

*Innovation in Motion*

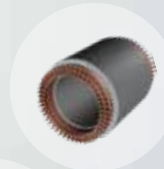

# Drive the eVolution

with a wide range of  
Miba parts for eMobility

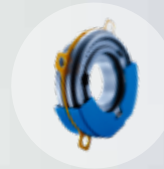

The background of the entire page is a wide-angle photograph of a modern city skyline at sunset. The sun is low on the horizon, casting a warm, golden glow over the buildings. In the foreground, a sleek, futuristic car with a metallic, glowing orange and silver finish is shown in motion, blurred to suggest speed. To the left, a white electric vehicle charging station is visible, with a green and white car plugged into it. The overall scene conveys a sense of advanced technology and sustainable urban mobility.

## Part of the eVolution: No eMobility Concepts Without Miba Components

Miba offers exactly the right components for all eMobility applications. Our outstanding development and system expertise combined with our long-term production experience allows us to offer a wide range of eDrive and hybrid drive systems. Together with vehicle manufacturers, we accelerate and successfully manage the transformation to eMobility – with Technologies for a Cleaner Planet.

We are aware that mobility and power generation will look completely different in the future and support our customers every day with pioneering technologies. We help them reduce carbon emissions, increase the efficiency of existing drive concepts, keep pace with the trend toward new alternative energy sources and much more.

# Products for eMotors

ADVANCED WINDING AND ASSEMBLY SYSTEMS FOR THE ELECTRIC MOTOR INDUSTRY



## ANALYSIS

- Magnetic plausibility
- Winding and insulation analysis
- Producibility studies



## PROTOTYPES

- A-, B- and C-samples
- Based on serial production
- Serial production tooling



## EQUIPMENT

- Hair-Pin and I-Pin stator assembly lines
- Fully automated
  - Highest quantities
  - 3rd generation/latest technology

## ELECTRIC MOTORS WITH SOFT MAGNETIC COMPOSITES

Miba soft magnetic composites (SMCs) allow the magnetic field to be conducted in all three dimensions without losses. This makes it possible to design compact and powerful electric motors with high power density and high torque density.

### Advantages of axial flux machines with SMCs

- High torque
- Package and weight (disc shape and high power density)
- NVH (very smooth running)
- Cost (easy assembly and replacement of rare-earth magnets)

### Advantages of claw-pole machines with SMCs

- Package and weight (high power density)
- Can be used also for high-speed rotating motors
- Ideal for applications with high torque at low rpm
- Assembly cost



# Products for eAxles and eGearboxes

## POWDER-METAL GEAR SOLUTIONS FOR eDRIVES

Components and assemblies with focus on NVH and light weight, high-revolution eMotors and high transmission spread

### Powder-metal gears

- Vibration-damping properties that reduce the emitted noise
- Ideal for electric powertrains with high-revolution eMotors thanks to NVH advantages
- Allow complex structures to realize lightweight designs and additional functions



SINTERED RING GEAR

DENSCAL® – HIGH-STRENGTH SHIFT ELEMENTS

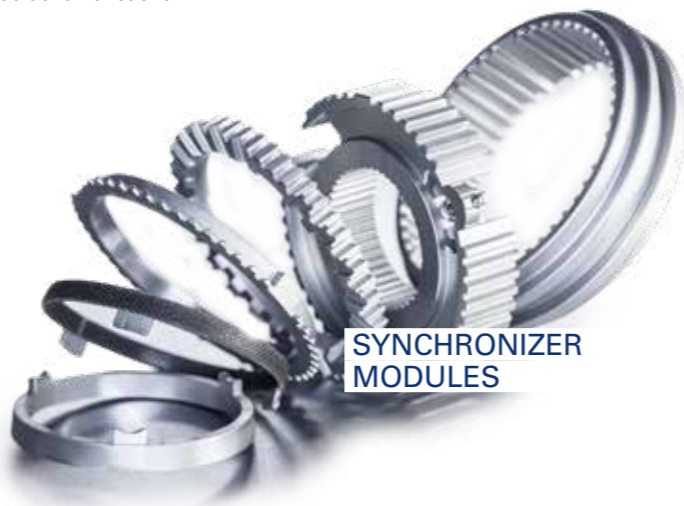

SYNCHRONIZER MODULES

## COATINGS

### SPACECOAT® – noise reduction solution

SPACECOAT® provides a well-defined gear clearance during assembly, which greatly improves engine acoustics. The polymer coating allows a simple, fast, accurate and cost-effective assembly.

### ADAPTOCOAT® – Optimization of contact area – NVH improvement

Adaptive coating to increase contact area and backlash in gear drive application to improve NVH; Leads to a significant reduction of noise.

SPACECOAT®

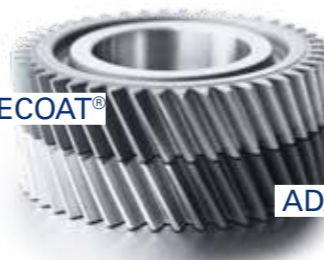

ADAPTOCOAT®



GRIPCOAT®

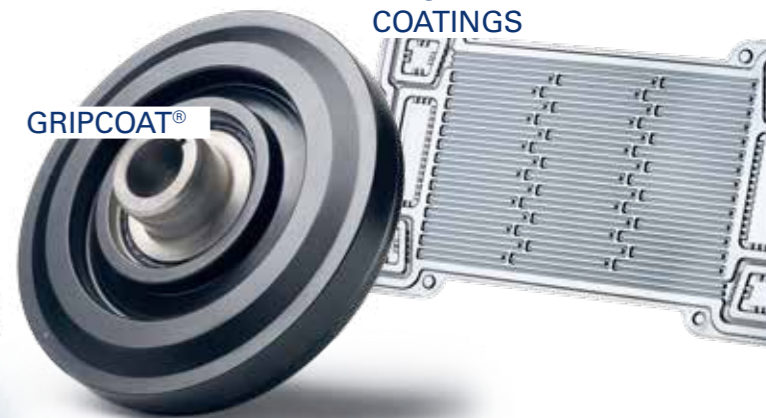

BIPOLAR PLATE COATINGS

### GRIPCOAT® Direct – Static friction increase up to factor 6

GRIPCOAT® Direct is the first process for directly applying selectively a friction-enhancing coating to components. Therefore reducing space and weight or increased transmitted torque and force of joining's.

### Bipolar plate coatings

Carbon- and Au-based PVD coatings for greater conductivity and corrosion resistance in fuel-cell applications.

# Power Electronics

Components and assemblies with focus on passive power

## POWER RESISTORS

- Thick-film technology for high-power systems
- Used in power distribution units (PDUs) and motor-controlling units (MCUs)



## VACUUM-BRAZED LIQUID-COOLED HEAT SINKS

- High-performance converters and switches
- Battery packs for vehicles



## CHARGING INFRASTRUCTURE

Components and assemblies with focus on passive power electronic components and thermal management

- Air-cooled heat sinks
- Water-cooled cold plates
- Vacuum-brazed heat sinks
- Heat pipes
- High-precision high-voltage resistors
- High-power resistors



## Friction Systems to Advance eMobility

### Ensuring driving enthusiasm with power shift and torque vectoring solutions

Our wide portfolio of adapted and dedicated friction systems supports torque transfer for top driving dynamics.

The key parameters are:

- Power density
- Efficiency
- Noise, vibration and harshness
- Total cost of ownership

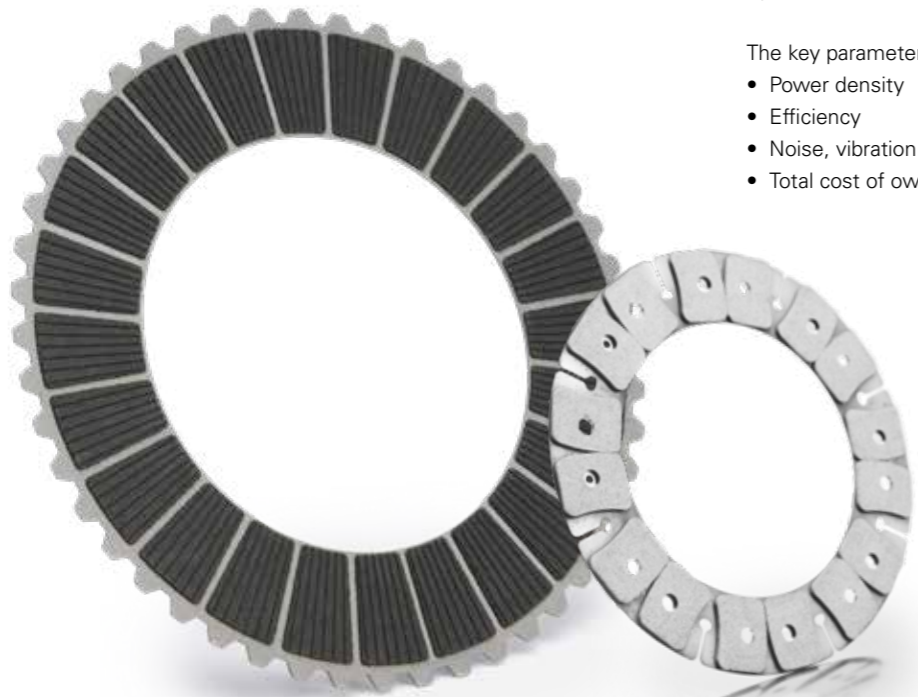

## Battery Cooling Components

### Liquid cooling component for a battery pack/module

Miba offers solutions for battery cooling at cell module and pack level.

### Heat pipe assembly

Removal of localized heat loads



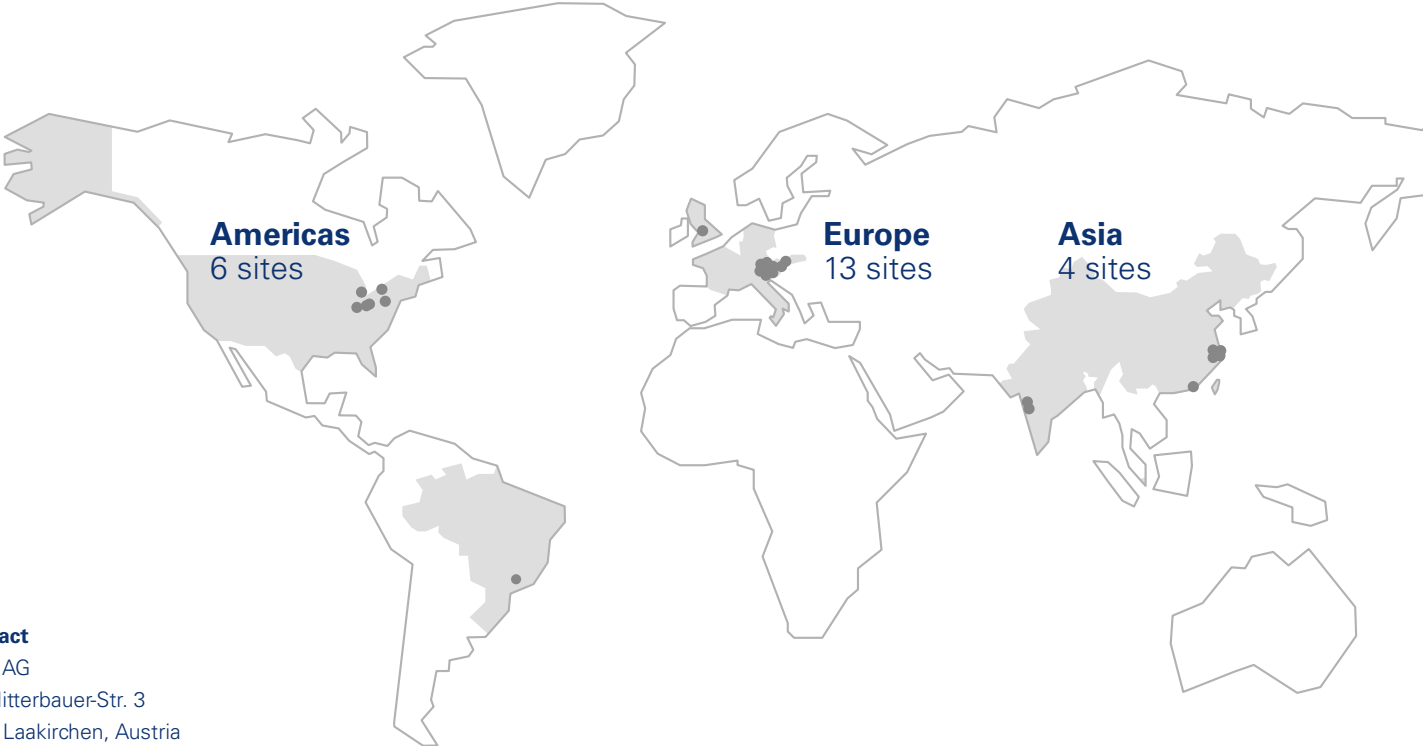

**Contact**

Miba AG  
Dr.-Mitterbauer-Str. 3  
4663 Laakirchen, Austria  
T +43 7613 2541 0  
info@miba.com